



# PS03

**Sistema scorrevole  
per ante in luce o a  
ridosso**

Sliding system for front  
or inside doors







# PS03

**Sistema scorrevole per ante in luce**  
Sliding system for inside doors

**Accessori complementari**  
Additional accessories

■ **PR20 - Ante in alluminio.**  
PR20 - Aluminium doors.

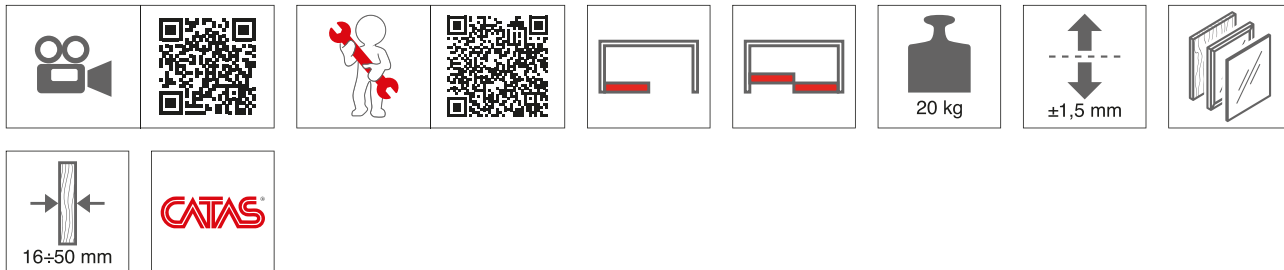

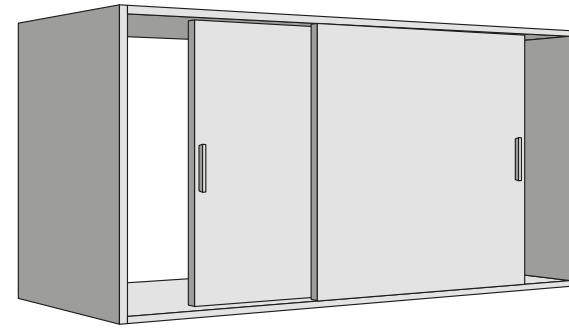
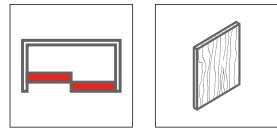

1

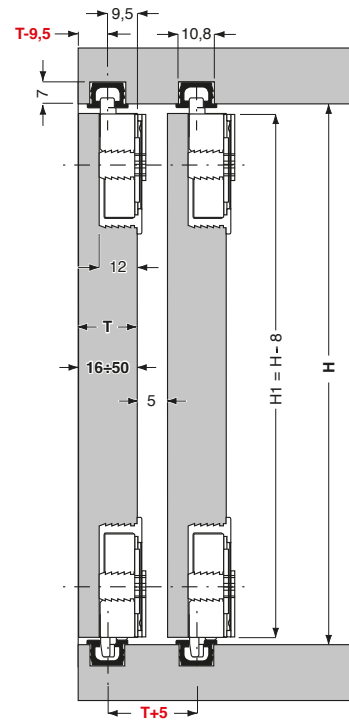

2

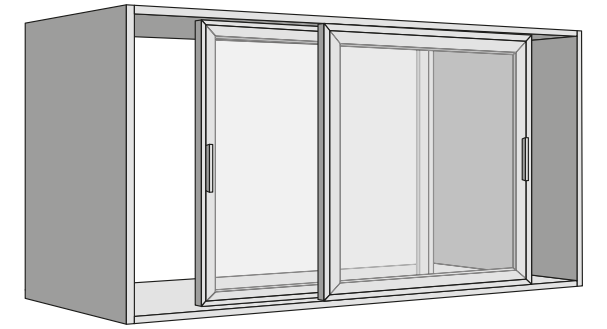
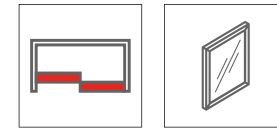
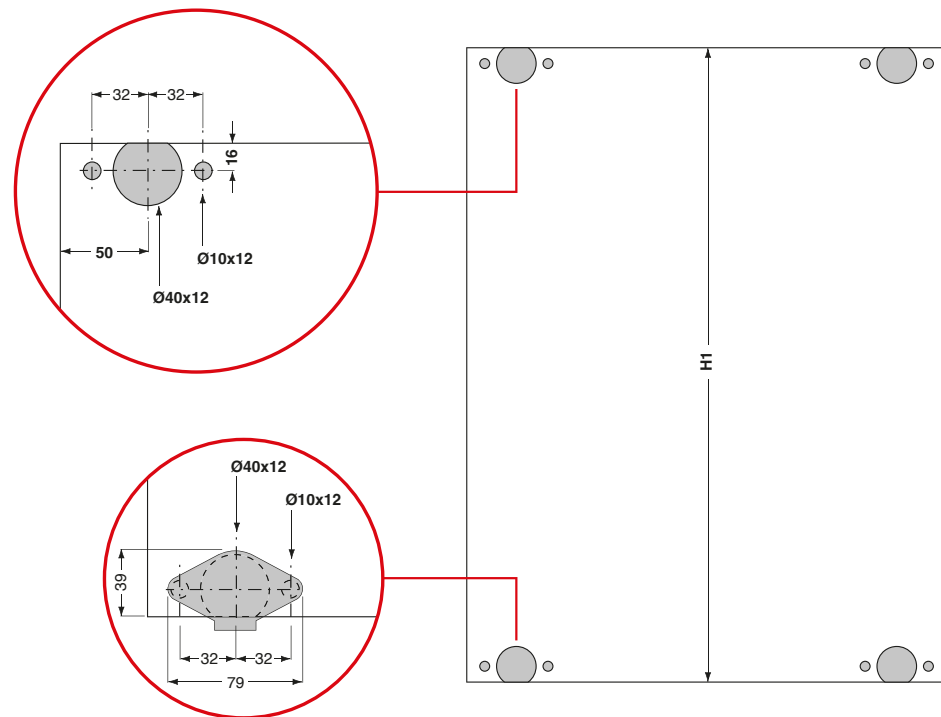

3

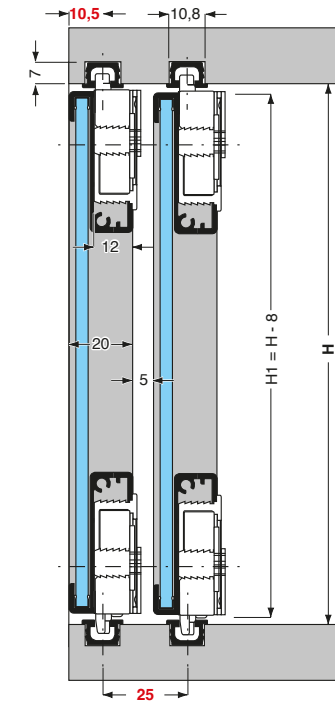

4

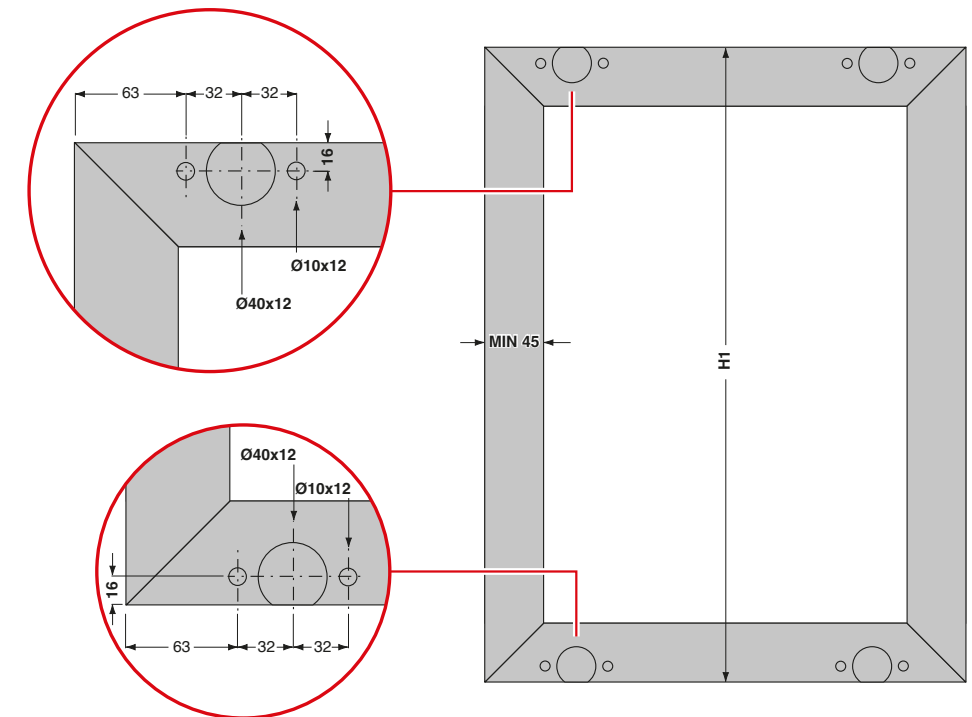

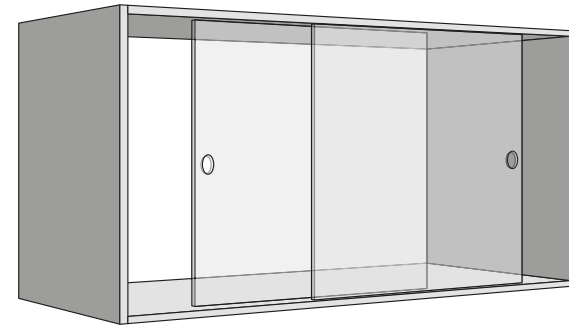
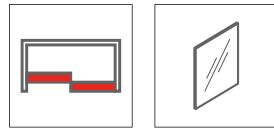

5

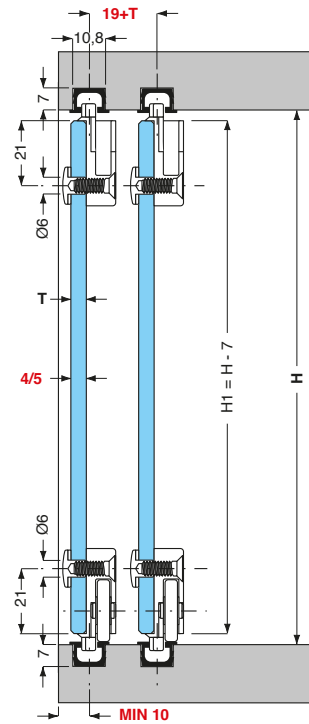

6

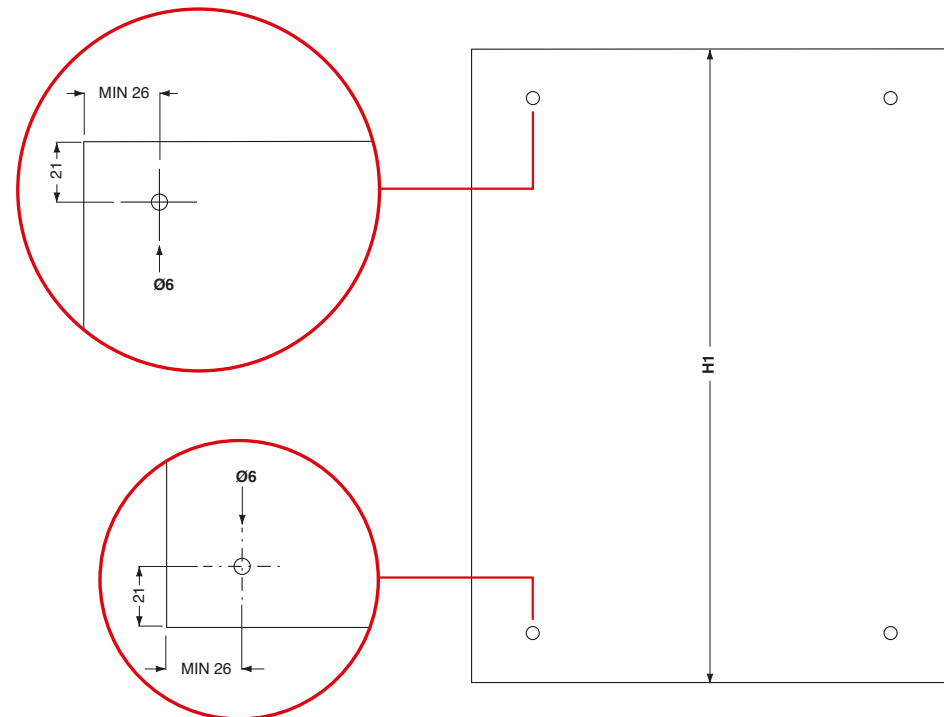

# Lista componenti / Parts list

## PR0370003A

Binario superiore - inferiore.

Upper - lower rail.

**Finiture standard / standard finishes**  
Anodizzato / anodized: Silver

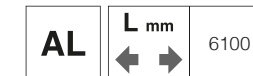
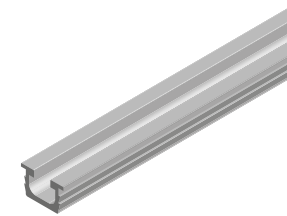
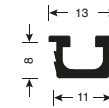

PR0383001A

White

PR0389001A

Brown

PR0390001A

Black

Binario superiore - inferiore.

Upper - lower rail.

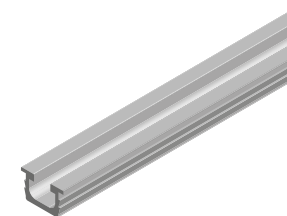
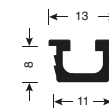

## PR038E001A

Binario superiore - inferiore.  
Finitura: Grigio metallizzato

Upper - lower rail.  
Finish: Metalized grey

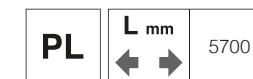
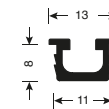

## PS03KP9005

Confezione anta.  
Finitura: Nero

Door kit.  
Finish: Black

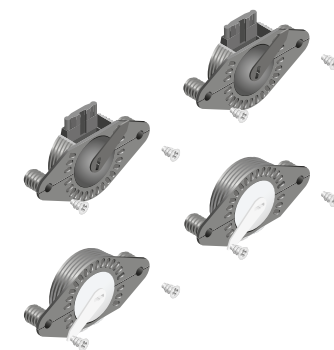

PS03FE8B02

Grey

PS03FE9002

Black

Fermo.

Lock.

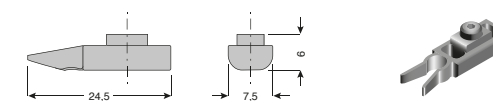

**PS03KP8E01** Grey  
**PS03KP9001** Black  
 Confezione anta.  
 Door kit.

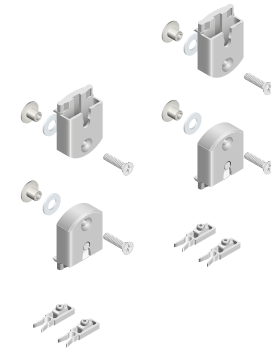

**PS03KP8E02** Grey  
**PS03KP9002** Black  
 Confezione anta.  
 Door kit.

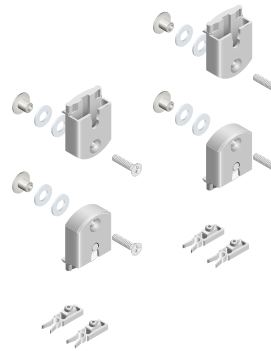

## Accessori complementari

### Additional accessories

**PR20**  
 Ante in alluminio.  
 Aluminium doors.

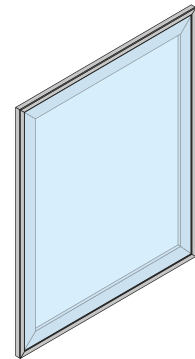

**VL60100609**  
 Eurovite a testa piana svasata con impronta a croce  
 POZIDRIVE Ø6,3x9 per fissaggio pattini.  
 Finitura: Zincato

Cross recessed countersunk (flat) head screw Ø6.3x9 for fix  
 slides.  
 Finish: Zinc plated

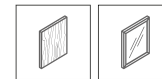
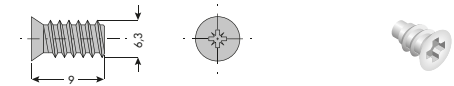



**Non utilizzare spray ed oli anti frizione o sblocca filetti sui cuscinetti o sulle ruote con O-ring dei pattini scorrevoli. Questo provoca lo scioglimento dei grassi dei cuscinetti rendendoli rumorosi oppure la rottura dell'O-ring.**

Do not use any anti-friction oil or grease or thread-release spray on ball bearing or on wheels with O-ring, it can cause the melting of the inside ball bearing grease, making them noisy or causing the break of the O-ring of the wheels.

Tutte le parti del catalogo sono di proprietà della Cinetto F.Ili S.r.l.

È vietata qualsiasi imitazione e copia delle illustrazioni, della grafica e la riproduzione, anche parziale, del presente catalogo senza autorizzazione.

I disegni tecnici e le informazioni dimensionali, incluse le illustrazioni, riportate in questo catalogo non sono vincolanti. L'azienda si riserva il diritto di apportare modifiche a fini migliorativi. Tutte le dimensioni sono in mm, se non diversamente specificate.

Si declina ogni responsabilità per errori di stampa.

All constituents of the catalogue are the property of Cinetto F.Ili S.r.l.

Reprint of the catalogue or extracts thereof, including those in the illustrations and imitation of the design is forbidden without permission.

The technical representations and dimensional information in this catalogue are non-binding, including those in the illustrations and drawings. Right reserved to make design improvements. All dimensions are in mm unless otherwise specified.

No liability accepted for printing errors of the catalogue.

Rilasciato da - Issued by  
Cinetto F.Ili S.r.l.  
Via Meucci, 4 - 35030 Rubano (PD) Italy

Tel. +39 049 8977211 - Fax +39 049 635822

Internet: [www.cinetto.it](http://www.cinetto.it) - Email: [info@cinetto.it](mailto:info@cinetto.it)

Dicembre 2024  
© by Cinetto F.Ili S.r.l.  
All rights reserved.  
Printed in Padova - Italy



**Sede Legale e Officina di Produzione**

Via Meucci, 4 - 35030 Rubano (PD) Italy

[www.cinetto.it](http://www.cinetto.it) - [info@cinetto.it](mailto:info@cinetto.it)

**Sede Amministrativa, Magazzino e Punto Vendita**

Via Rossi, 5/A - 35030 Rubano (PD) Italy  
Tel. +39 049 8977211 - Fax +39 049 635822  
C.F./P.I. (VAT) (IT) 00277120283

