

PS19.1

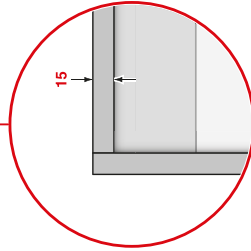

Parte visibile: 15 mm
Visible part: 15 mm

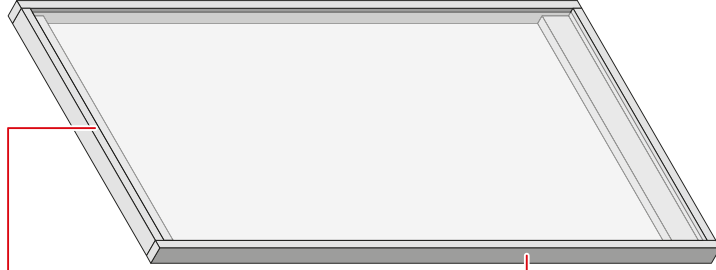
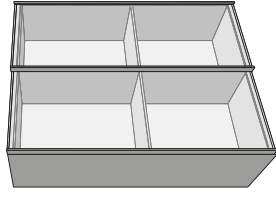
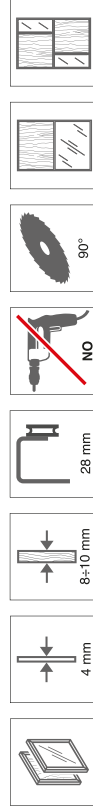
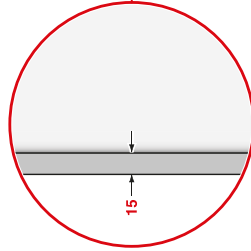

PS19.1. Schede tecniche / Data sheets

1

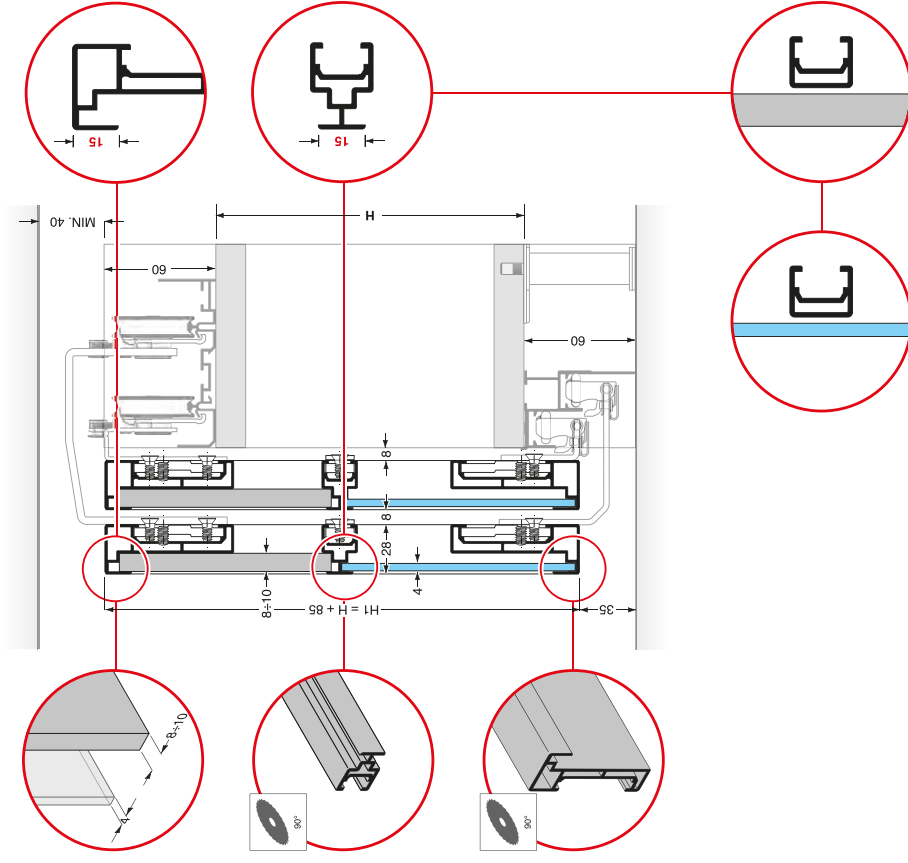

Pattini compatibili / Compatible slides.

PS48AP2E2801

PS48AP2E01

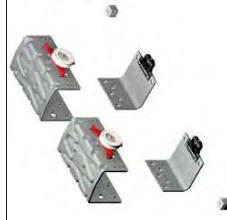

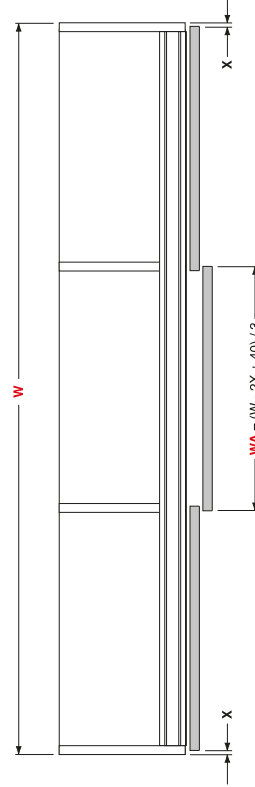
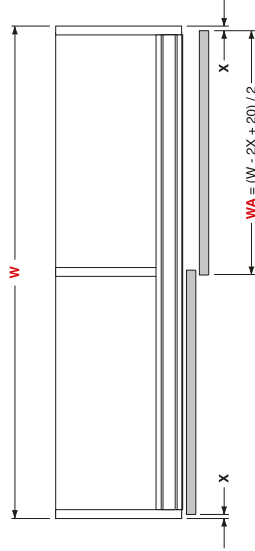
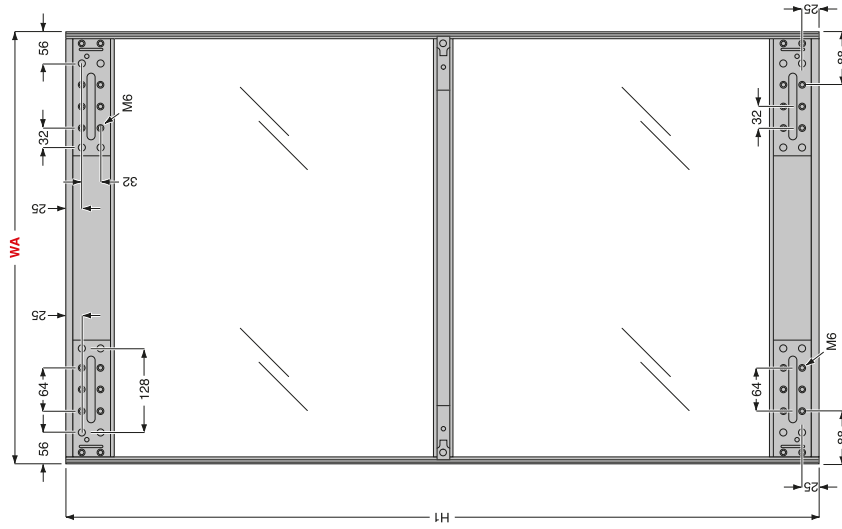

ABBREVIAZIONI:	
W	= larghezza
WA	= larghezza ante
ABBREVIATIONS:	
W	= width
WA	= door width

PS19.1

PS19.1. Lista componenti / Parts list

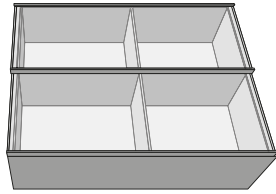

Fianco laterale con recuperò
Long lateral side

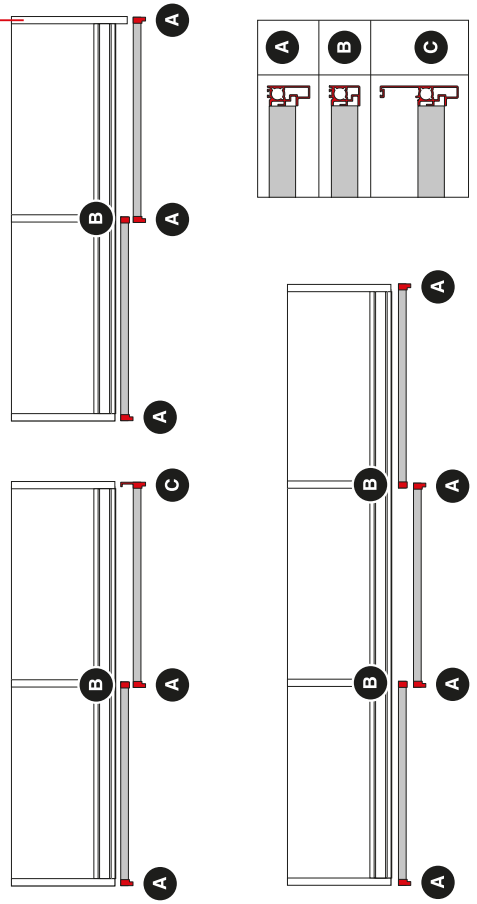

PR1970008A

Profilo maniglia bassa.

Narrow handle profile.

Finiture standard / standard finishes

Anodizzato / anodized: Silver
Verniciato / painted: Deep black, Metal grey, Moonlight

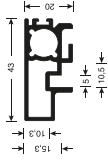

PR1970007A

Profilo montante verticale.

Vertical rod profile.

Finiture standard / standard finishes

Anodizzato / anodized: Silver
Verniciato / painted: Deep black, Metal grey, Moonlight

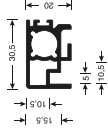

PR1970009A

Profilo maniglia alta.

Wide handle profile.

Finiture standard / standard finishes

Anodizzato / anodized: Silver
Verniciato / painted: Deep black, Metal grey, Moonlight

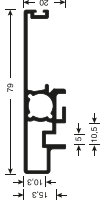

PR1970020A

Profilo traverso superiore - inferiore.

Upper - lower horizontal profile.

Finiture standard / standard finishes

Anodizzato / anodized: Silver
Verniciato / painted: Deep black, Metal grey, Moonlight

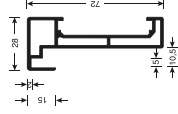

PS19CS1001

Confezione per montaggio anta.

Finitura: Zincato

Kit for assembly door.

Finish: Zinc plated



14x

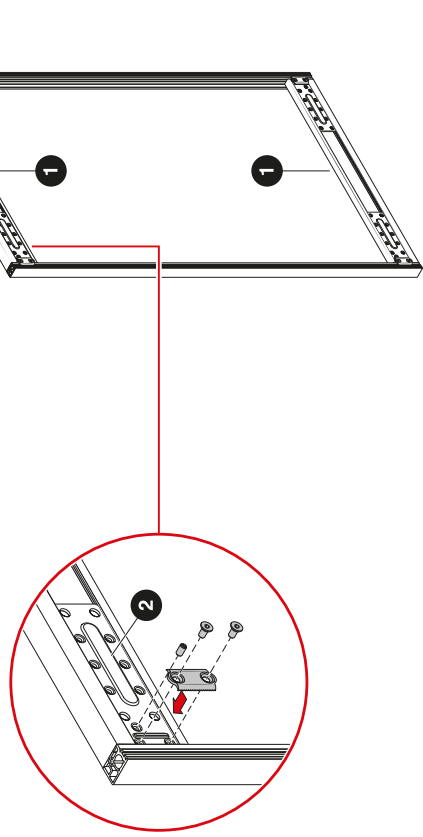

PS19.1

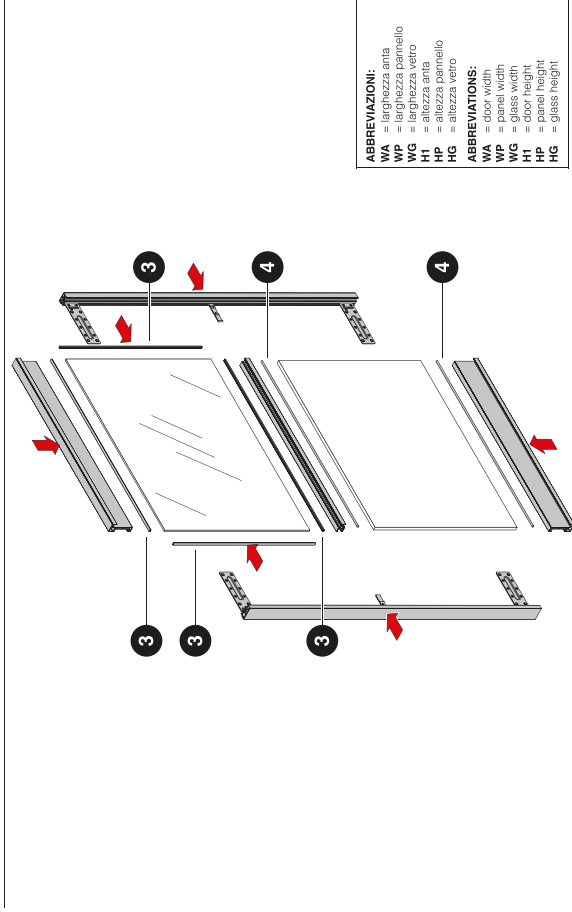
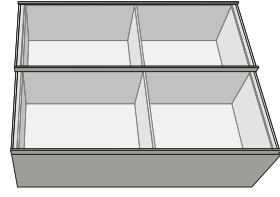
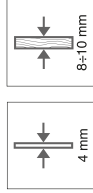

ABBREVIAZIONI:
 WA = larghezza anta
 WP = larghezza pannello
 WG = larghezza vetro
 H1 = altezza anta
 HP = altezza pannello
 HG = altezza vetro

ABBREVIATIONS:
 WA = panel width
 WP = glass width
 WG = glass width
 H1 = door height
 HP = panel height
 HG = glass height

PR20820004

Guarnizione per vetro.
 Finitura: Neutro

Gasket for glass.
 Finish: Neutral

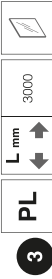

TE238B0001

Profilo tondo di compensazione Ø3 per pannello da 8 mm.
 Finitura: Grigio

Round profile of compensation Ø3 for panel 8 mm.
 Finish: Grey

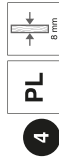

Calcolo dimensioni vetri e pannelli suddivisi in parti uguali.
 Calculation of the dimensions of glasses and wooden panels divided in equal parts.

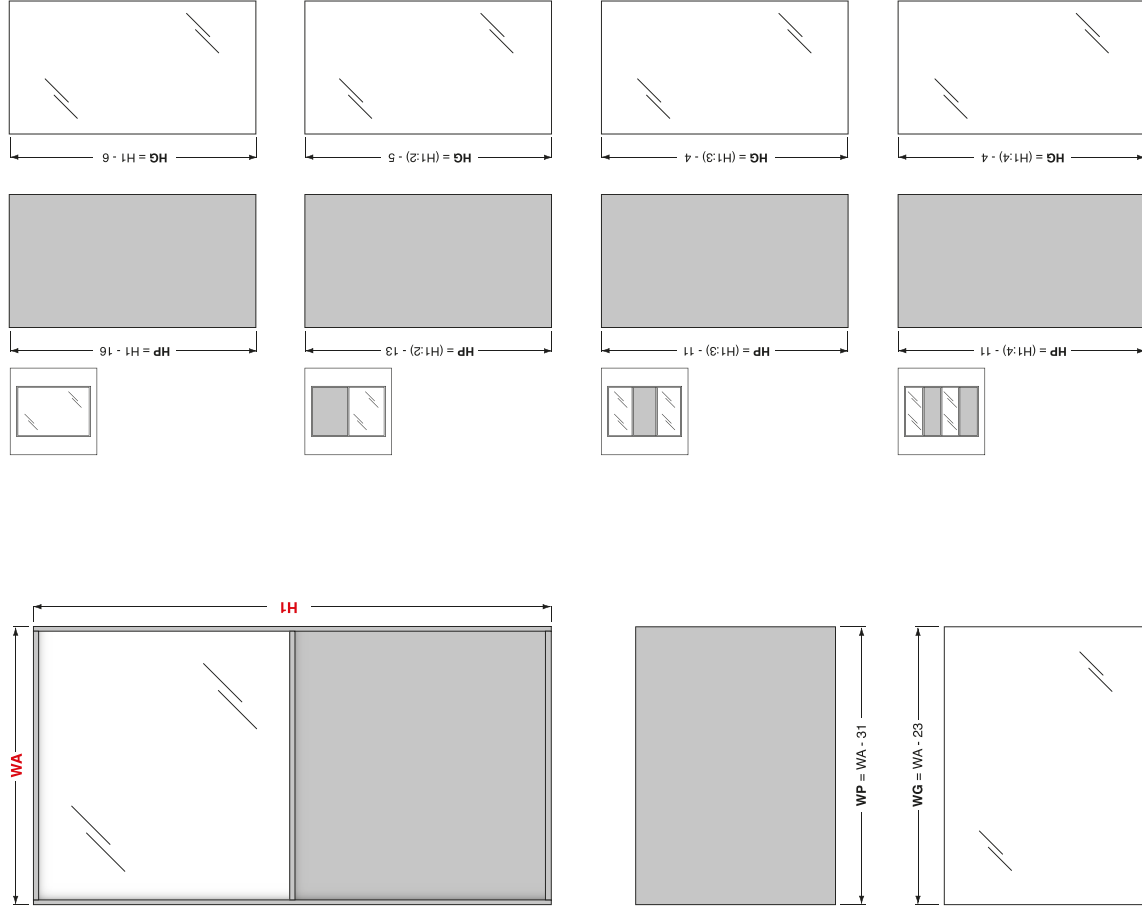

PS19.1

option
2

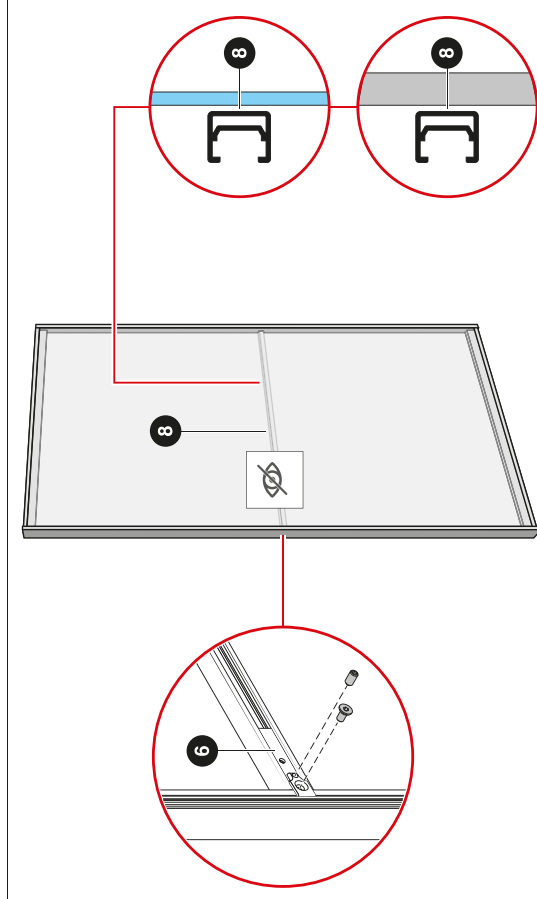

PR1970021A

Profilo traversino senza sede vetro.

Cross profile without glass gasket seat.

Finiture standard / standard finishes

Anodizzato / anodized: Silver
Verniciato / painted: Deep black, Metal grey, Moonlight

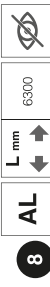

PS19CS7212

Confezione per montaggio traversino orizzontale.

Finitura: Silver

Kit for assembly horizontal cross profile.

Finish: Silver



PS19.1. Lista componenti / Parts list

Accessori complementari Additional accessories

PZ03480590A

Spazzolino parapolvere.

Finitura: Nero

Save-dust brush.

Finish: Black



BR

Raddrizza ante.

Doors straightener.

