

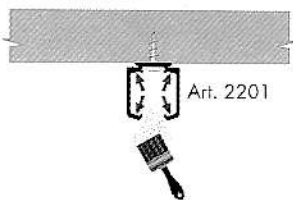

ISTRUZIONI / INSTRUCTIONS
KIT Art. 2479-2479/B



PULIRE IL BINARIO DOPO IL FISSAGGIO
CLEAN THE PROFILE AFTER FIXING



AVVERTENZE IMPORTANTI - WARNING

FISSARE IL BINARIO IN PERFETTA POSIZIONE ORIZZONTALE
FIX THE PROFILE IN PERFECT HORIZONTAL POSITION

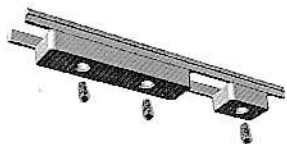
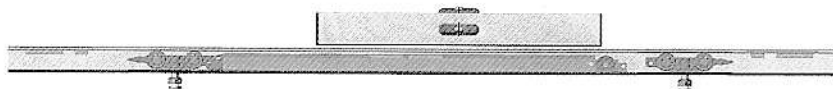

AVVERTENZA IMPORTANTE
WARNING

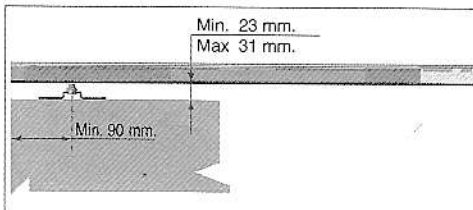
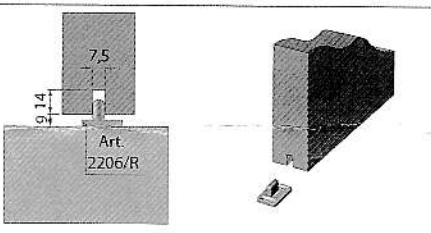
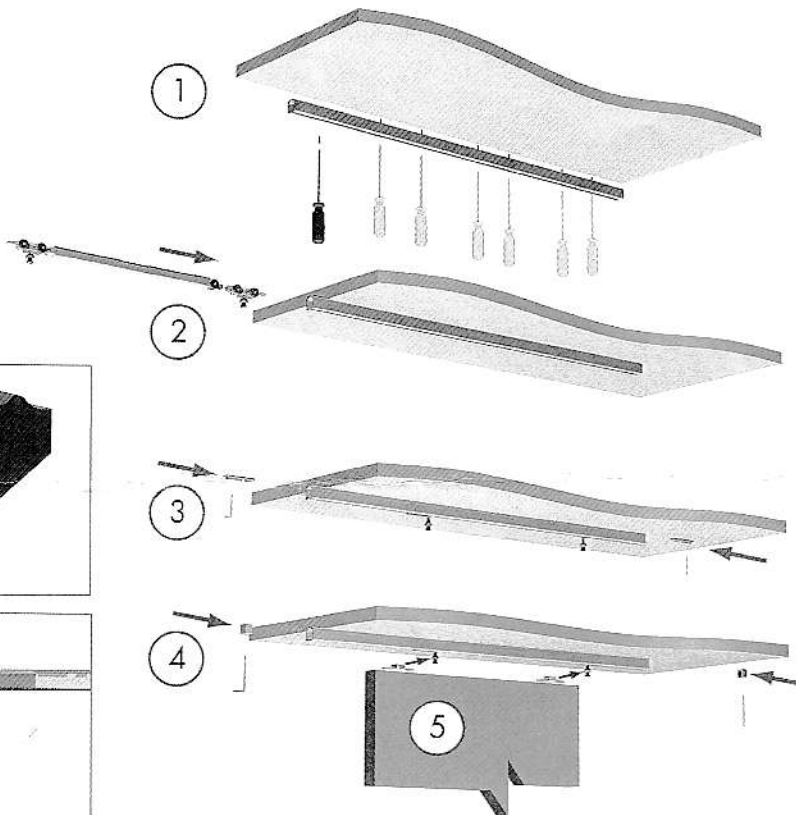
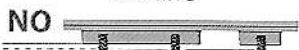

SERIE
2200/4200

