

МЕХАНИЗМИ ЗА ИНТЕРИОРНИ ВРАТИ

СИСТЕМА ЗА ПЛЪЗГАЩИ СЕ ВРАТИ

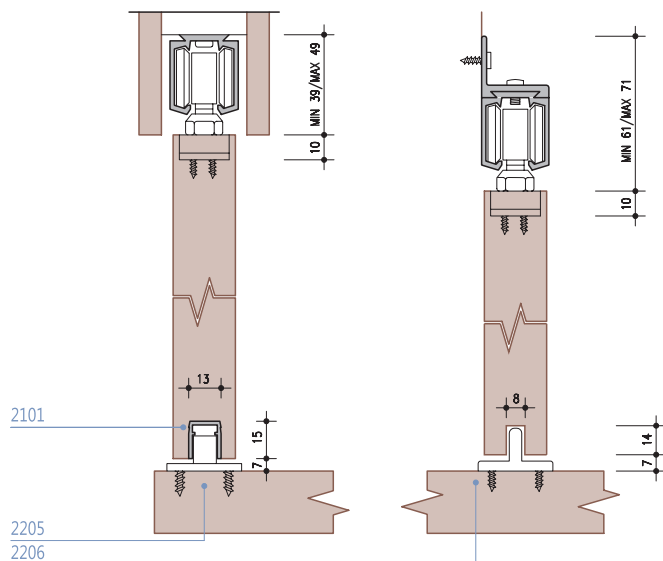

Товароносимост: 40 кг, 60 кг или 100 кг без плавно прибиране
5663 – до 80 кг, с плавно прибиране; мин.шир.на вратата 572 мм.
2479/B/S – до 100 кг, с плавно прибиране; мин.шир.на вратата 680 мм..

СИСТЕМА ЗА СГЪВАЩИ СЕ НЕСИМЕТРИЧНИ ВРАТИ

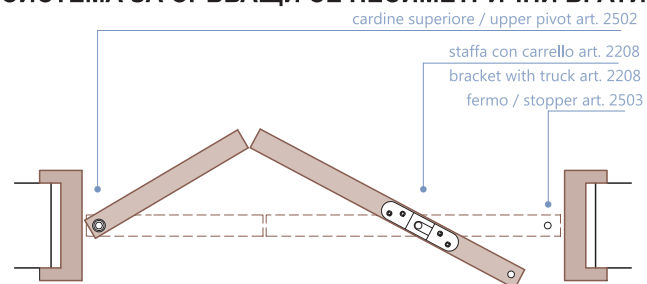

Товароносимост: 60 кг общо

СИСТЕМА ЗА СГЪВАЩИ СЕ СИМЕТРИЧНИ ВРАТИ

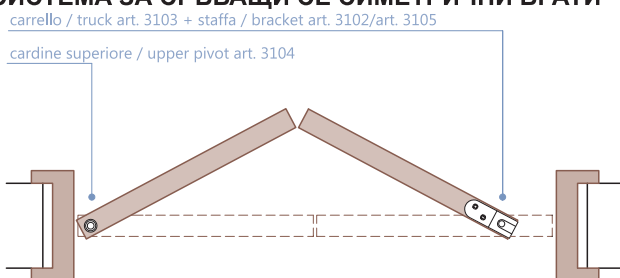

Товароносимост: 25 кг общо

МЕХАНИЗЪМ 5881/130 ЗА СЪКЛЕНА ИНТЕРИОРНА ВРАТА

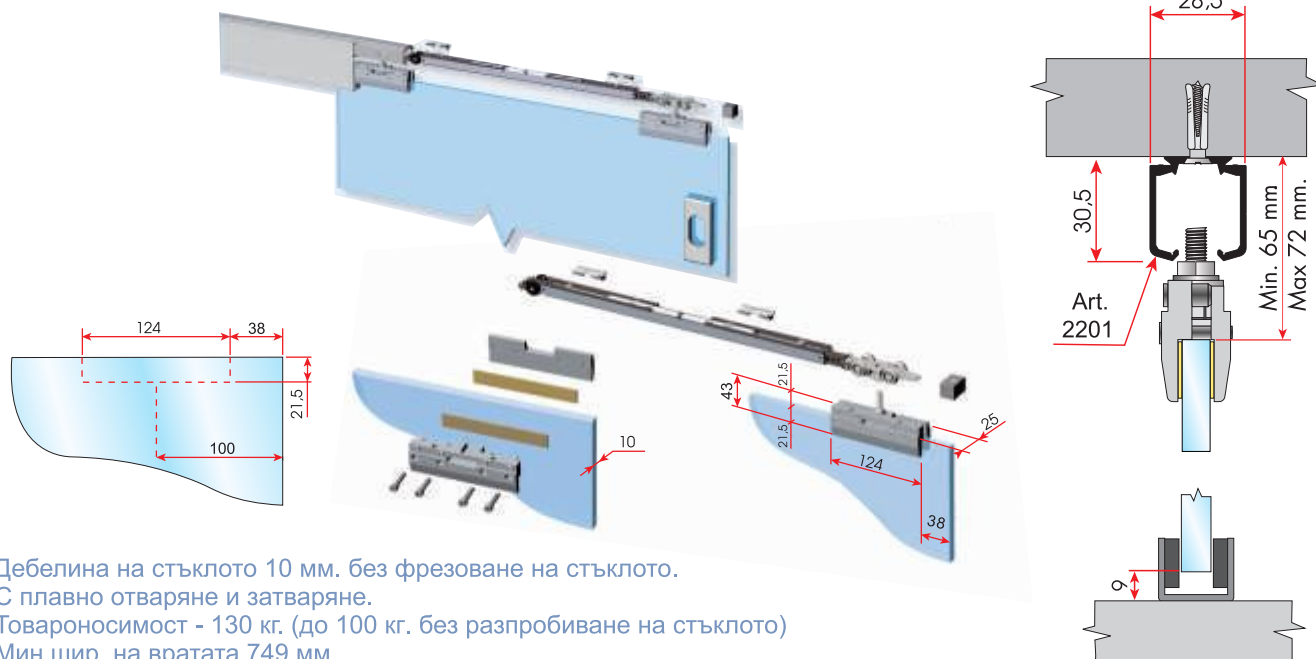

Дебелина на стъклото 10 мм. без фрезование на стъклото.
 С плавно отваряне и затваряне.
 Товароносимост - 130 кг. (до 100 кг. без разпробиване на стъклото)
 Мин.шир. на вратата 749 мм

КОМПОНЕНТИ

2206/R - перо



2208 - водач 100 кг.

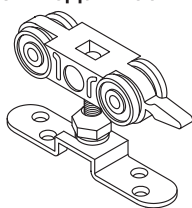

2503 - стопер за 2500

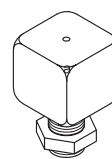

2401/G - релса лека, L=6.0м

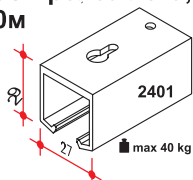

2203 - водач 60 кг-

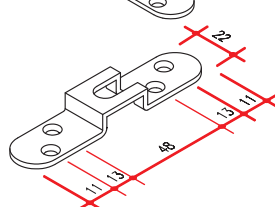
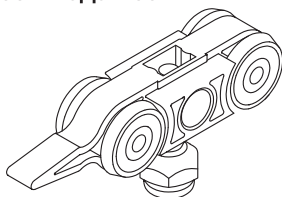

2525 - панта скрита

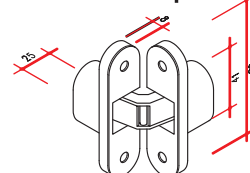

2402 - планка за стена за лека релса 2401/G

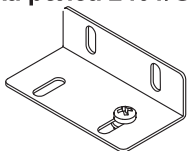

2519 - панта средна

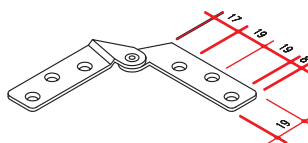

3103 - водач единичен

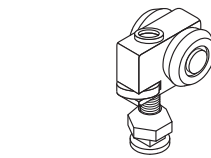

2201/G - релса тежка, L=6.0м

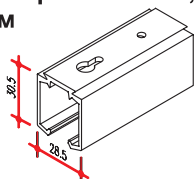

2207 - стопер

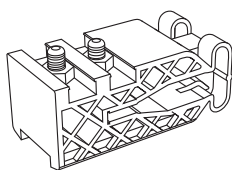

2502 - ос горна

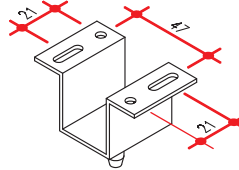

3103 - водач единичен

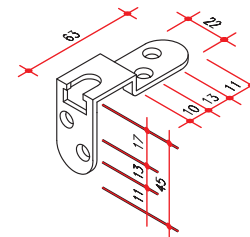

2202 - планка за стена за тежка релса 2201/G

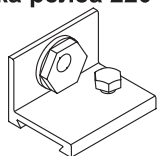

2205 - перо за релса за нут 2101

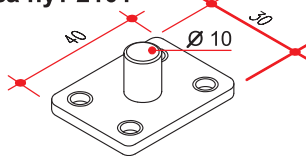

2505 - ос долна

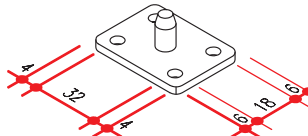

3104 - ос горна скрита

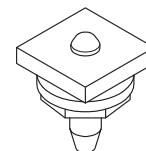

2101/G - релса за нут

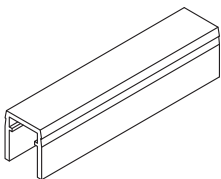

2510/R Г перо

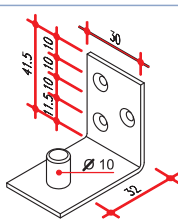

2510 - ос долна Г към каса

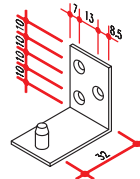

5203 - панта средна усилена

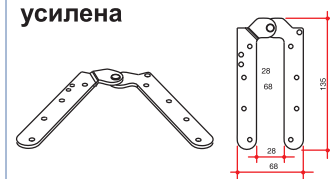

2214 - водач 40 кг.

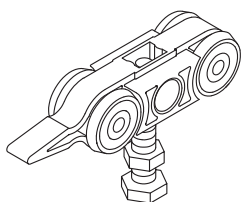

2247

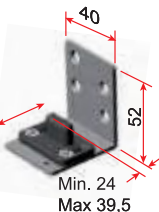

2501 - втулка за ос

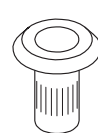

5203/M - панта средна усилена с фиксатор

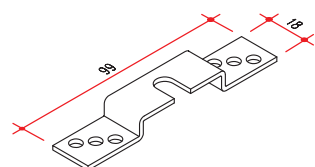
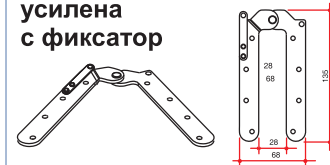

2251 - ограничител

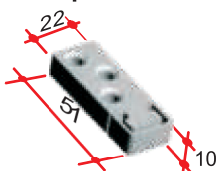

2504 - дистанционер

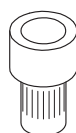

2204 - ключе 8/16 мм.

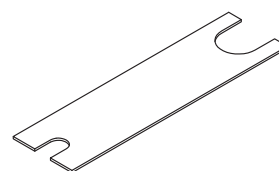

Villes2000 *made in italy*

**МЕХАНИЗЪМ ЗА ИНТЕРИОРНА ПЛЪЗГАЩА СЕ ВРАТА
СЪС СКРИТА РЕЛСА 6212
ТОВАРОНОСИМОСТ 80 кг.
ВЪЗМОЖНА ШИРОЧИНА НА ВРАТАТА ОТ 626 мм. до 1200 мм.
МИНИМАЛНА ДЕБЕЛИНА НА ВРАТАТА 30 мм.**



